

DAKOTA BODIES

CUSTOM IS THE STANDARD

CUSTOM BODIES



FIRST SHIPMENT

Dakota Bodies first shipment hits the road on time.



1997



SECOND EXPANSION

Dakota Bodies makes the move to a new 20,000 sq. ft. facility in Watertown, SD

2000

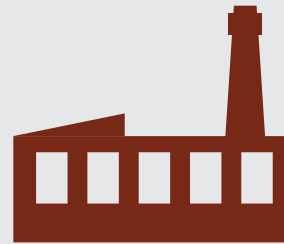

2003

NORTHLANDER EDITION

Dakota Bodies designs and manufactures the Northlander Edition

THIRD EXPANSION

Dakota Bodies blows out a wall turning their space into a 40,000 sq. ft. facility.

2004

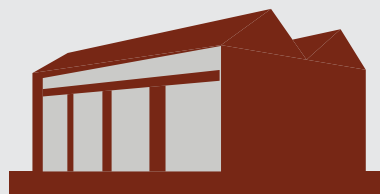

COMPONENT BODY

Dakota Bodies designs and manufactures the Component Body. Winning the 2011 NTEA New Product Award

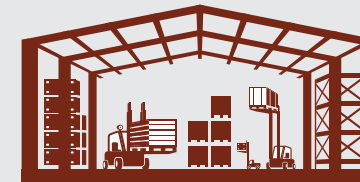

FIFTH EXPANSION

Dakota Bodies completes a 45,000 sq. ft. expansion to meet production demands.



2005

CUSTOM ALUMINUM

Dakota Bodies begins mass producing aluminum truck bodies.

2010



2010

FOURTH EXPANSION

Dakota Bodies takes over a 100,000 sq. ft. facility.

2014

E-SERIES CUTAWAY

Dakota Bodies designs and manufactures the Cutaway Body.

2015



The Company

Dakota Bodies has been building quality utility and service truck bodies in Watertown, South Dakota since 1997. Over those years Dakota has grown into a 145,000 sq. ft. facility with over 250 employees, making them one of Watertown's top employers. The history of quality and innovation has led them to be one of the nation's top choices in the utility and service industries. As a growing manufacturer, Dakota Bodies continues to invest into their future with new technologies and techniques to better serve their customers.

Engineering

At Dakota Bodies, design engineering is an important service in the process of manufacturing quality and effective bodies for every market. Whether you have a complete spec in mind or need input on design and capabilities, the design team at Dakota is there to help. Combining state of the art software with decades of experience, results in a well designed Dakota Body. If you find yourself wondering if it can be done, ask. Their design team will be able to answer the questions and discuss options to ensure you receive the most functional body for your application.

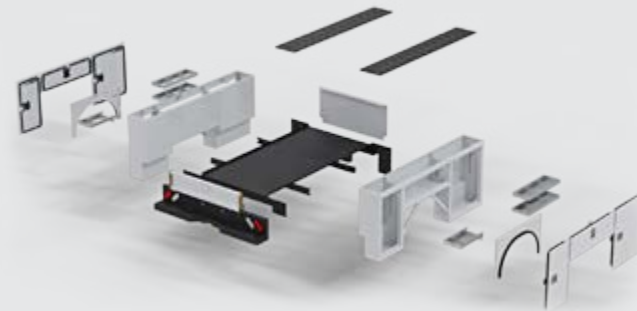

Manufacturing

With state of the art fabrication equipment, products are set up for a quick and successful trip through our shop. This provides faster turnarounds of all bodies, boxes and accessories. The streamlined hard working environment around Dakota is second to none and provides the quality expected every time.



The future...

Dakota Bodies is continuing national growth and as result will be expanding their facility plans to be operational in the new expansion by early 2018. The 17,000 sq. ft. addition will expand plant capacity and increase production efficiency. The company looks to continue this growth through their custom design and manufacturing abilities.

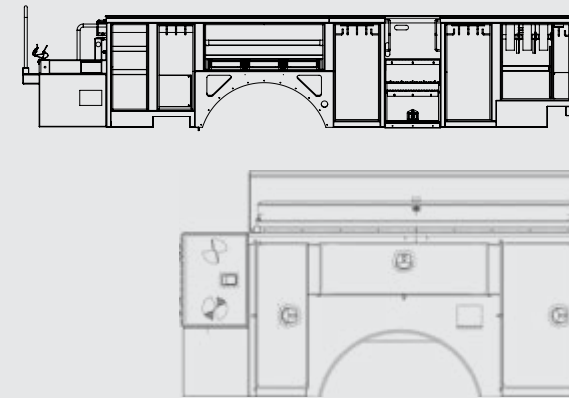

Custom is the standard

Dakota Bodies understands that efficiency and productivity are key which is why "custom is the standard". A plumber and a power lineman need different trucks, different tools and overall different configurations to properly complete their jobs. Dakota Bodies allows you to customize every aspect and your ideas can be designed and engineered to fit your needs.

Why the Bison?

Because of their strength, speed and resilience to extreme weather.



Table of Contents

ALUMINUM

- 10 year corrosion warranty
- Less weight
- Increased payload
- Less wear and tear on chassis
- Save fuel
- Corrosion resistant
- Increased residual value
- 100% recyclable
- Partially constructed out of recycled materials
- Available in powder coat finish

8 Aluminum Service Body

10 Aluminum Flat Bed

12 Aluminum Line Body

14 Aluminum Flat Bed

STAINLESS



- 10 year corrosion warranty
- 16 Ga. stainless steel main body exterior
- 14 Ga. stainless steel fender panels
- 14 Ga. stainless steel bulkhead
- Stainless steel rear light bar and skirt (if equipped)
- 18 Ga. A-60 galvanized double panel doors
- Stainless steel rod and socket door hinges
- 250 lb. capacity galvanized shelving
- 12 Ga. tread plate floor
- 6" x 8.2 lb. structural steel understructure
- Prime paint complete (powder coat available)

16 Northlander Service Body

18 Northlander Line Body

20 Northlander Superstructure

22 Northlander Line Body

GALVANNEAL

- 6 year rust through warranty
- 16 Ga. A-60 galvanized exterior
- 14 Ga. A-60 galvanized fender panels and bulkhead
- 18 Ga. A-60 galvanized double panel doors
- 14 Ga. tread plate compartment tops
- 12 Ga. tread plate floor
- Stainless steel rod and socket door hinges
- 250 lb. capacity galvanized shelving
- Prime paint complete (powder coat available)

24 Galvanized Line Body

26 Galvanized Flat Bed

28 Galvanized Superstructure

30 Galvanized Line Body





Flip-top divider trays on street side and curbside



Custom rotating vents for kennel compartments



Piano hinge, flush mounted kennel doors with slam latch

CUSTOM ALUMINUM SERVICE BODY

LENGTH: 108" / WIDTH: 96" / HEIGHT: 40" / WEIGHT: 1,050 LBS



At Dakota Bodies no request is over looked, even a dog kennel in the first vertical. This body also features flip-top compartments with divider trays on both side packs, T-handle latches in the compartment doors and slam latches on the kennel doors. The designer also included drain holes and customized kennel vents which can easily be closed in harsh weather conditions. The bed area of this body is complete with 4 recessed d-ring tie downs that are mounted flush with the floor and a hinged Dakota Bodies tailgate.

ADDITIONAL FEATURES:

- Dog kennel transverse compartment
- Dog kennel vents
- Flip-tops with divider trays
- Dri-deck compartment liners
- Adjustable divider shelves
- Whale-tail compression t-handle latches
- Recessed D-ring tie downs
- Recessed rear lights
- Powder coat finish



Custom grab-pool handles and a stainless steel bar handle for support.



Recessed side access on both curbside and street side.



Custom bolt-on storage box which doubles as a step area for easy access.

CUSTOM ALUMINUM FLATBED

LENGTH: 172" / WIDTH: 96" / HEIGHT: 56" / WEIGHT: 1,600 LBS

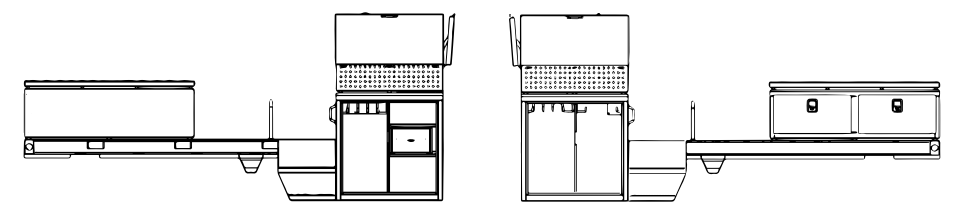

This custom aluminum flatbed is both lightweight and versatile with recessed step areas on both sides of the body. The inset bed area behind the bulk head provides additional storage and easy access to the lift up top boxes. With the curbside compartment housing a massive 60" roll-out drawer this flatbed certainly doesn't lack storage capacity. The bolt-on storage box located on the bed of the body features a grip strut top for additional steps and drop down doors for quick access to the bolt in shelves.

ADDITIONAL FEATURES:

- Under-body wheel chock storage
- Recessed D-Ring tie downs throughout bed area
- Interior swivel hook storage
- Gas strut flip top doors
- Internal stake pockets



Custom tail-board with custom grab handles to handle multiple work scenarios.



Custom ladder box with a stainless steel stop and composite roller for easy operation.

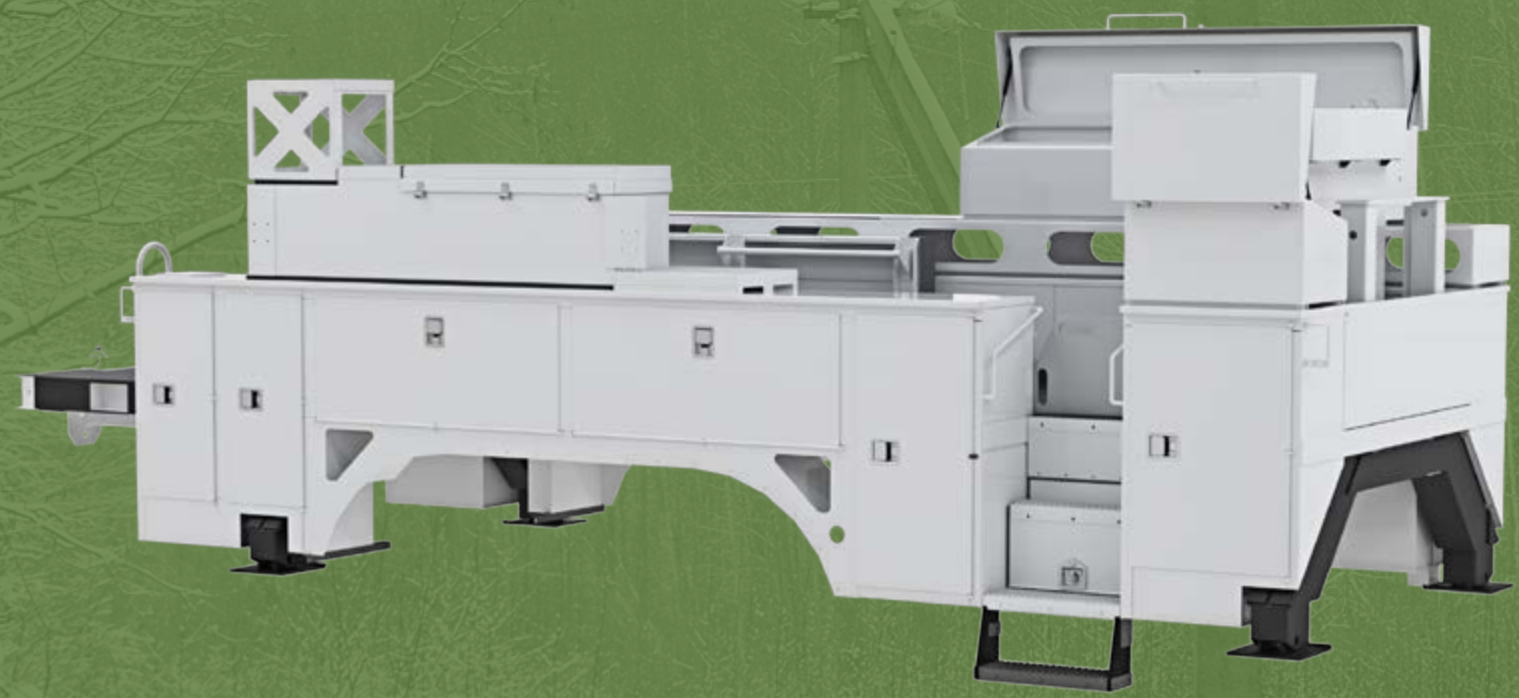

Custom bolt-on top boxes with tapered lids and rubber vents.

CUSTOM ALUMINUM LINE BODY

LENGTH: 231" / WIDTH: 93" / HEIGHT: 48" / WEIGHT: 3,100 LBS

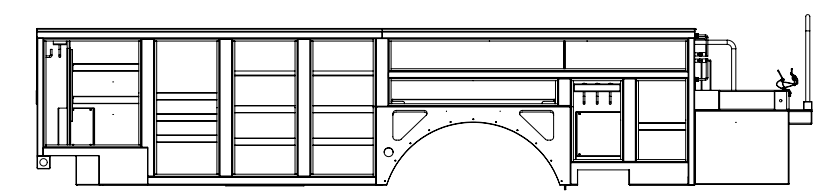
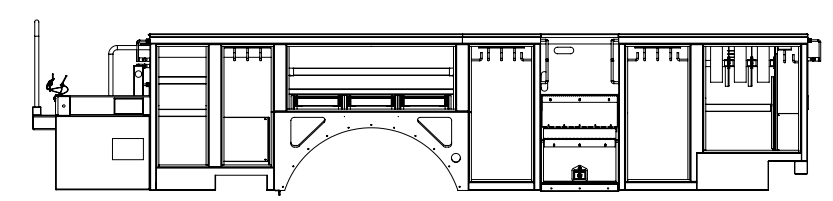

The customizations on this aluminum utility line body created a body 231" long while maintaining a slender 93" width. This body was designed to be efficient and organized.

ADDITIONAL FEATURES:

- Aluminum grab handles
- Custom tail-shelf with recessed tail-board
- Fixed drawer cabinet storage
- Adjustable swivel hooks
- Adjustable shelves with dividers
- Wire reel holder
- Easy access tail shelf
- Recessed D-rings in floor of tail shelf
- 182" ladder box
- Cross arm storage
- Tie down bar
- Bolt-on flip top boxes
- Hot stick brackets

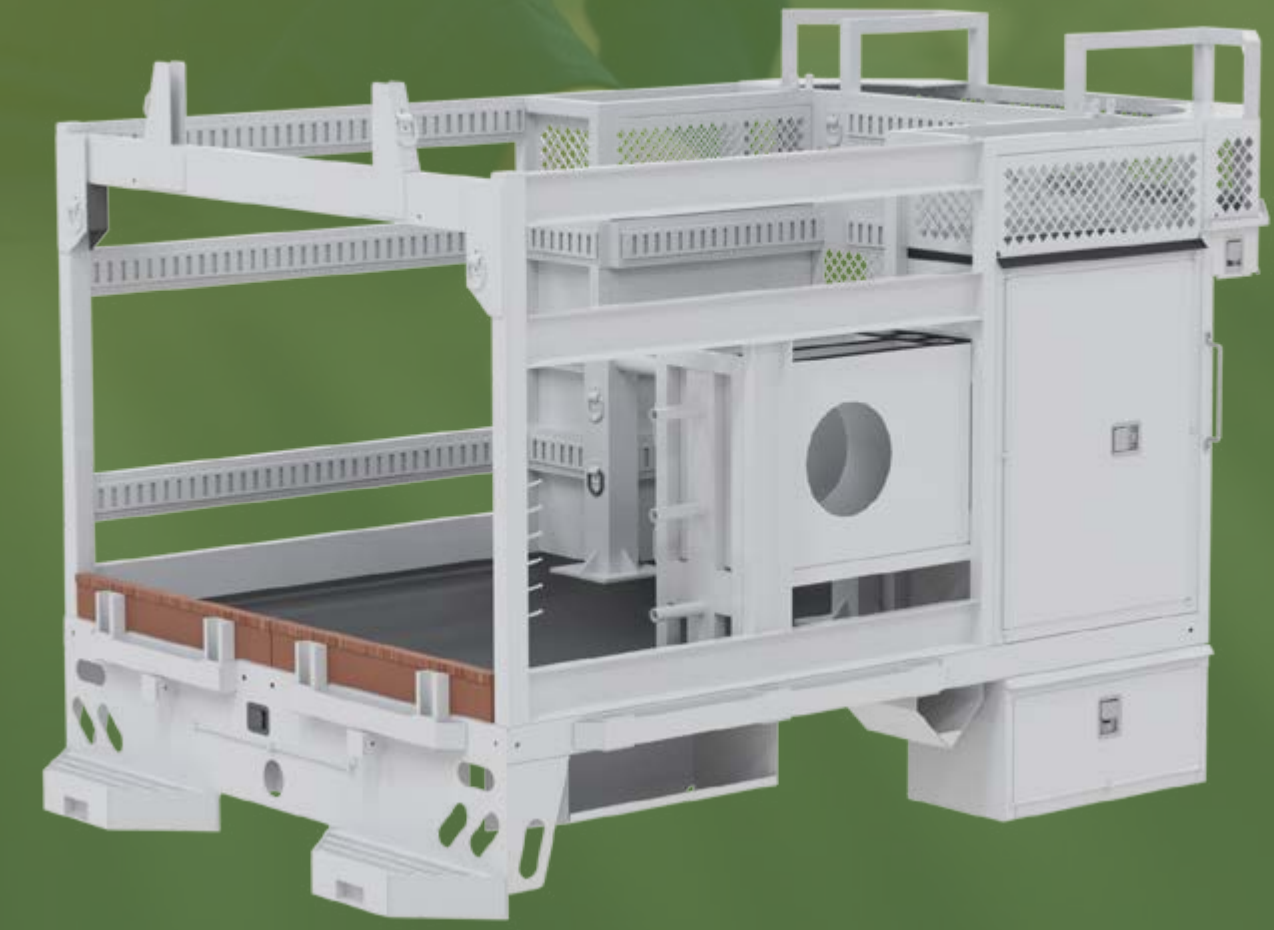
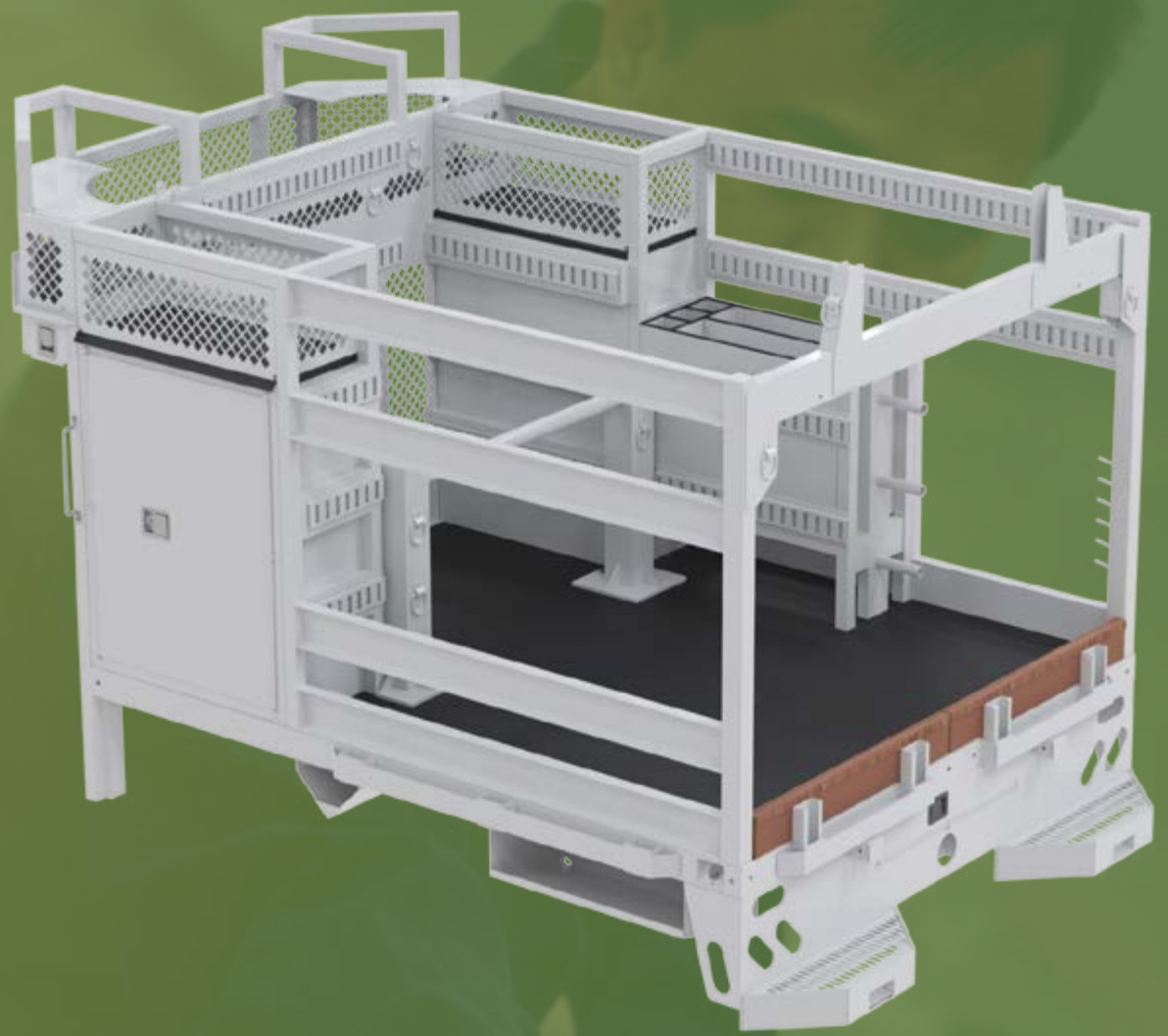

Custom rear skirt with light holes, rear steps and signholder boxes located on both sides.



View of the custom compartments located in the front of the body.

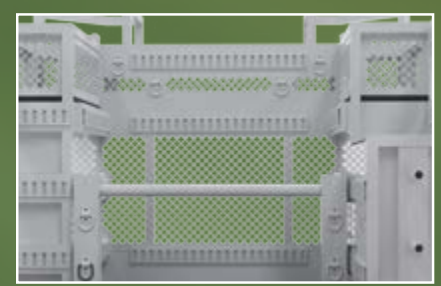

This view from the rear of the body displays the various tie down options and locations.

CUSTOM ALUMINUM FLATBED

LENGTH: 148" / WIDTH: 93" / HEIGHT: 95" / WEIGHT" 2,165 LBS

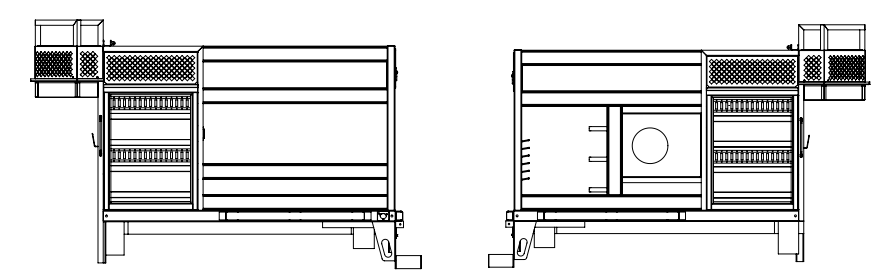

This aluminum flatbed is loaded with custom accessories from the punched metal baskets to maximize storage to the unique storage compartments with stainless steel slam latches. The bed area includes custom wire rack holders and removable stake pocket tail boards for easy loading/unloading. Both E-track and D-ring tie down systems are located throughout the bed area to provide the best load securement for any size load. The rear skirt with light holes and the hinged flip-up rear bumper steps ensure clearance is never a problem.

ADDITIONAL FEATURES:

- Barn style front vertical compartments
- Shovel holders located on the front of the body
- Possum storage at rear of body
- Adjustable divider shelves in vertical compartments
- Under body storage boxes
- Under body chock holder storage
- E-Track system in vertical compartments



Punched metal baskets with access from bed area and the ground using "beer truck" step rail.



Adjustable hooks in the bed area using uni-strut rails.



Flip up rear bumper steps allow for proper angle of departure. Also includes a vise mount.

CUSTOM NORTHLANDER SERVICE

LENGTH: 108" / WIDTH: 94" / HEIGHT: 74" / WEIGHT: 3,400 LBS

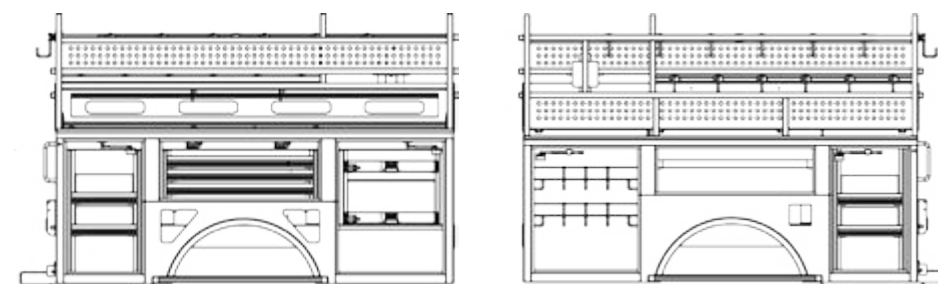

Use the Northlander Edition to maximize rust and corrosion protection. This unique service body is full of quick access storage and simple efficient accessories such as E-track storage, adjustable hooks and a custom spare tire holder. The overhead material rack allows for the adjustable hooks to be up and out of the way while still providing access to the top mounted punched metal baskets. The flip top lid allows maximum clearance and easy step access with the "beer truck" style step rail located in the wheel well. The first vertical on the curbside is a deep compartment containing 60" pull-out drawers. The recessed rear lights give this body a sleek complete look.

ADDITIONAL FEATURES:

- Flip up rear bumper steps
- "Beer Truck" step rails
- Adjustable carriage bolt hooks
- Lock-in / Lock-out drawers with finished plastic faces
- 2 - 12" x 60" pull out drawers with dividers
- Floor mounted D-ring tie downs in bed area
- Hinged rear tube on material rack

CUSTOM NORTHLANDER LINE BODY

LENGTH: 190" / WIDTH: 94" / HEIGHT: 48" / WEIGHT: 6,200 LBS

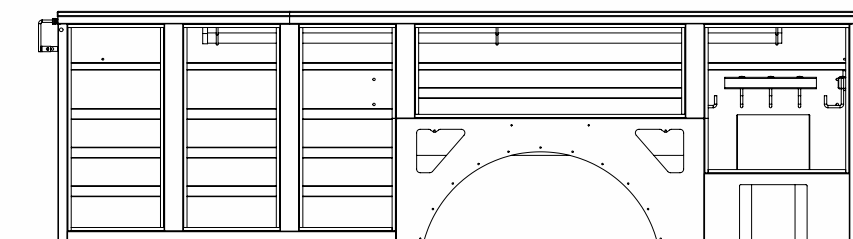
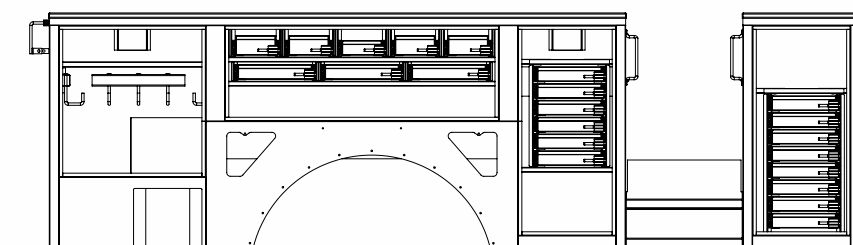

Custom vertical ladder storage



Egg crate storage in the bottom of the horizontal compartment



Bed rails and flip top boxes complete with grip-strut tops for skid free steps

Even with stainless steel Northlander body configurations the customizations are not limited. Multiple flip top boxes holding sliding trays and egg crate storage dividers give this body a custom look at first glance. The custom belt style steps provide quick and easy access to the bed area which is complete with a tail board and a bulkhead storage box. The bed area also features rope rail storage and wire reel storage.

ADDITIONAL FEATURES:

- Control box covers
- PVC canister kit
- Flip-tops with divider trays
- Cab guard step
- Egg crate divider storage
- Thumb latch drawers in multiple compartments
- Custom rope rail
- Strap steps
- Custom light bar with steps
- Custom wire reel rack

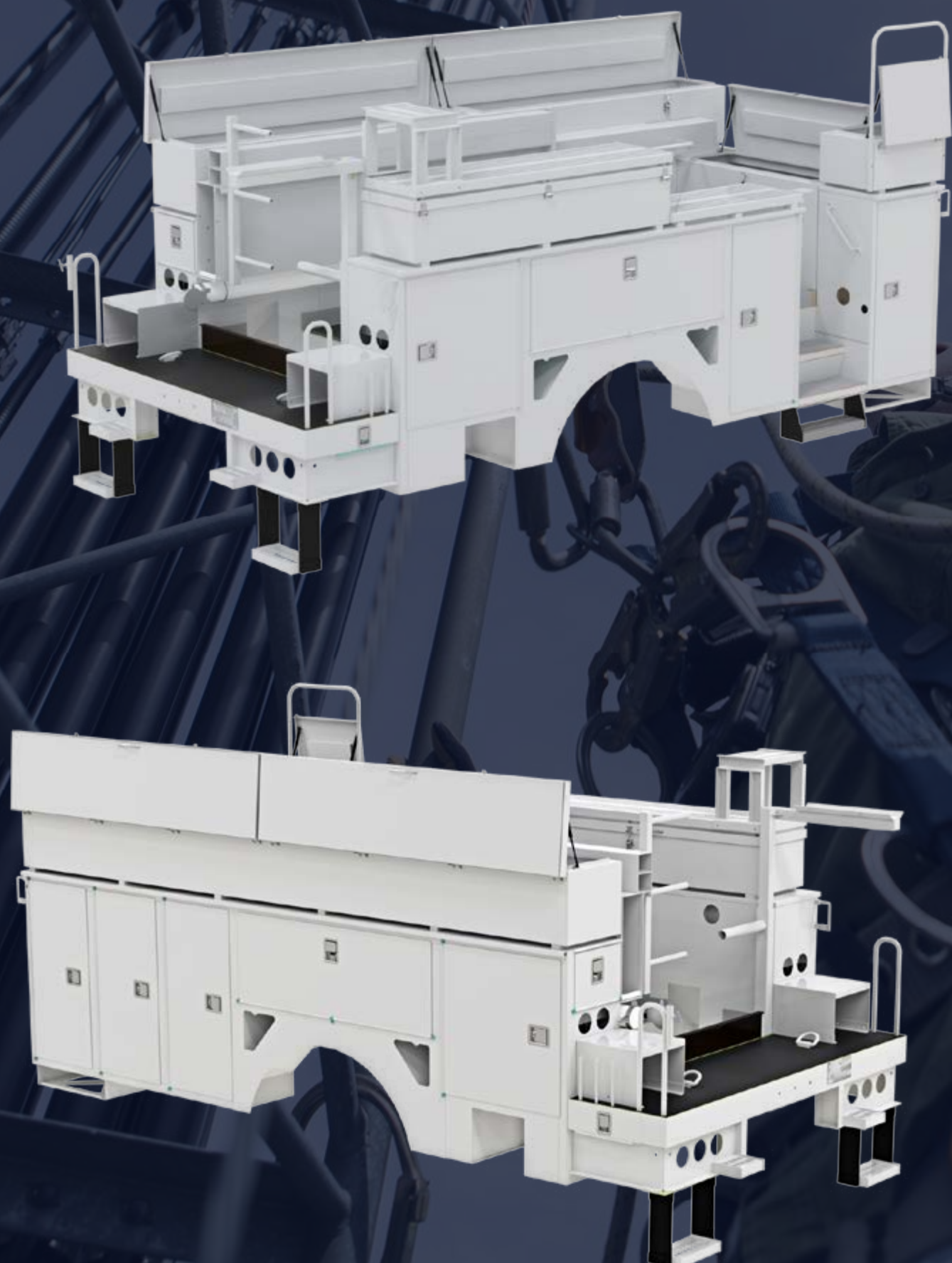



Recessed bumper steps



Barn style rear doors to maximize opening and bed security



CUSTOM NORTHLANDER SUPERSTRUCTURE

LENGTH: 118" / WIDTH: 94" / HEIGHT: 59" / WEIGHT: 2,540 LBS



This small super structure is designed off of our standard Service Body using a V configuration on the street-side and an H configuration on the curb-side. The bed area includes barn style doors to maximize the door opening and allow for a 37.5" roll out Slide-master tray. The tray extends 80" outside of the body for access to all of the cargo.

ADDITIONAL FEATURES:

- Master-lock system
- Internal LED lighting for the enclosed bed area
- Recessed tail lights
- Split step bumper

CUSTOM NORTHLANDER LINE BODY

LENGTH: 232" / WIDTH: 94" / HEIGHT: 66" / WEIGHT: 6,000 LBS

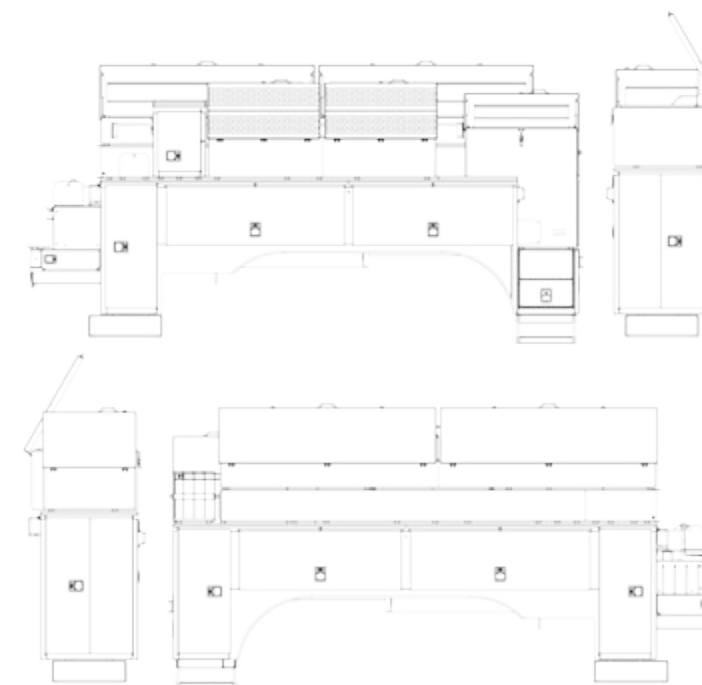

From the transverse to the tail shelf box this body is loaded with custom options and custom designed accessories. With a tandem axle configuration the stretched design allows for two large horizontal compartments and massive bolt-on top boxes. On top of the customized transverse compartment is a custom aluminum wire rack utilizing otherwise wasted space. Pad holders are located on all four corners of the body. The bed area features both E-track storage, D-ring tie downs and a composite tail board.

ADDITIONAL FEATURES:

- Wire reel holders
- Cross arm storage box
- Enclosed ladder box
- 120" Material rail
- Grip-strut steps and platforms
- Adjustable hooks
- T-Handle drawers
- Custom tool holders
- Custom bit holders



Custom wire reel holders and valve covers



Custom pad holders and wheel chock holders

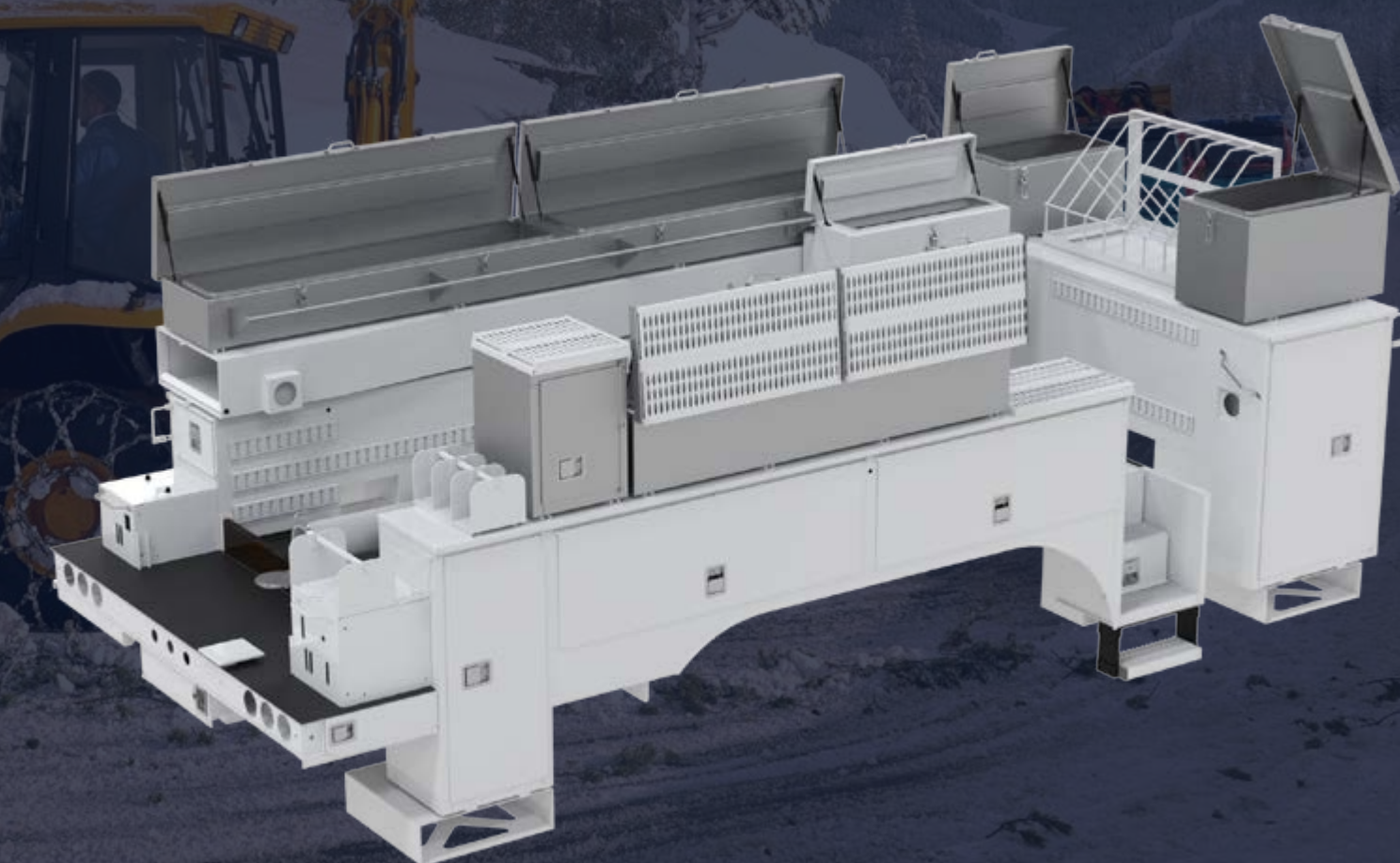

Custom step area with flip up box and rubber belt step

CUSTOM GALVANNEAL LINE BODY

LENGTH: 232" / WIDTH: 96" / HEIGHT: 76" / WEIGHT 4,375 LBS

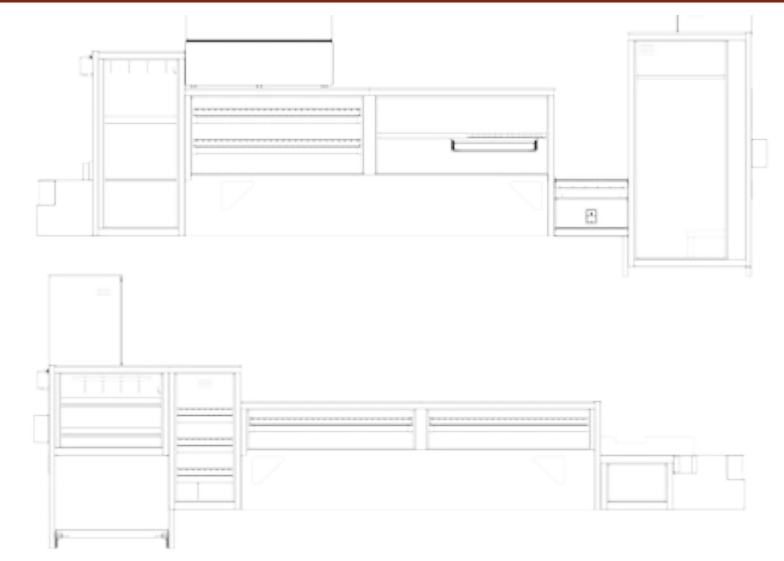

Earlier we stated no request was overlooked. The insulated curbside 1st vertical includes a toilet and septic tank complete with a lockable door and a vent in the roof. Now, you have restroom access no matter where the job takes you. The tandem axle body also includes a pull-out generator tray on the street side allowing for easy access for maintenance and repair on the generator. Every compartment is unique on this body in shape and size which provides ample storage for all gear and accessories.

ADDITIONAL FEATURES:

- Custom adjustable hooks
- Adjustable shelves
- Chainsaw box
- Bed access locker storage
- Wheel chock holders
- Adjustable divider trays
- Recessed rear lights
- Pull-out generator tray
- Removable tail board
- Master-lock system

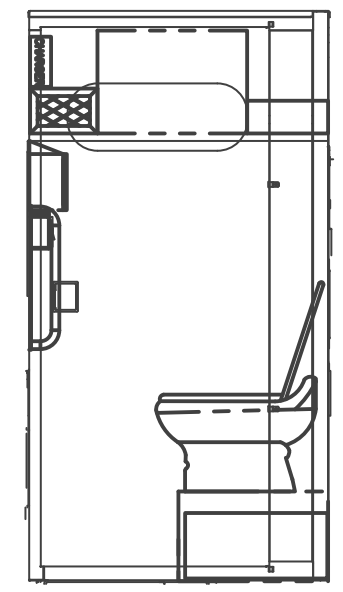

Custom pull out generator tray for easy access and maintenance



Flip top boxes for additional storage

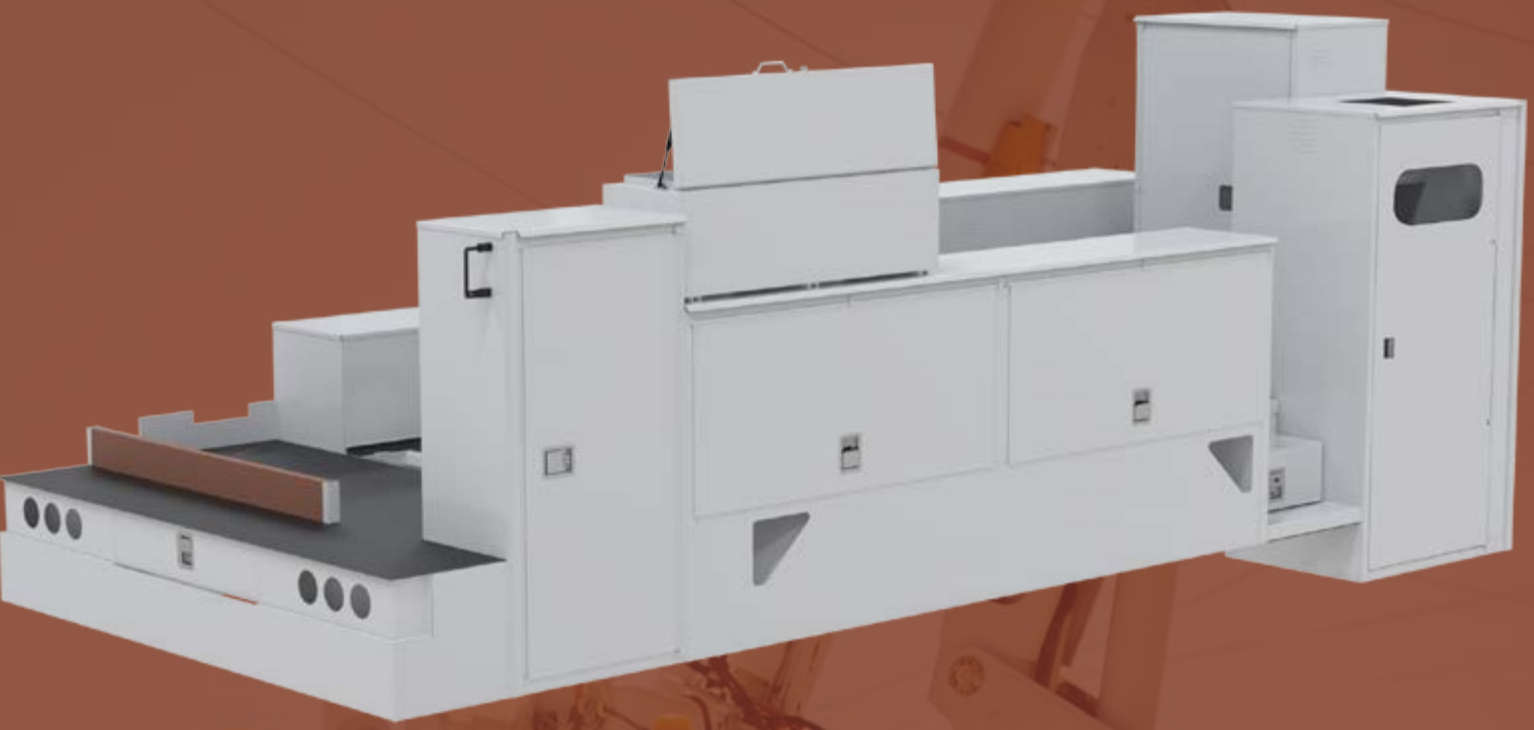

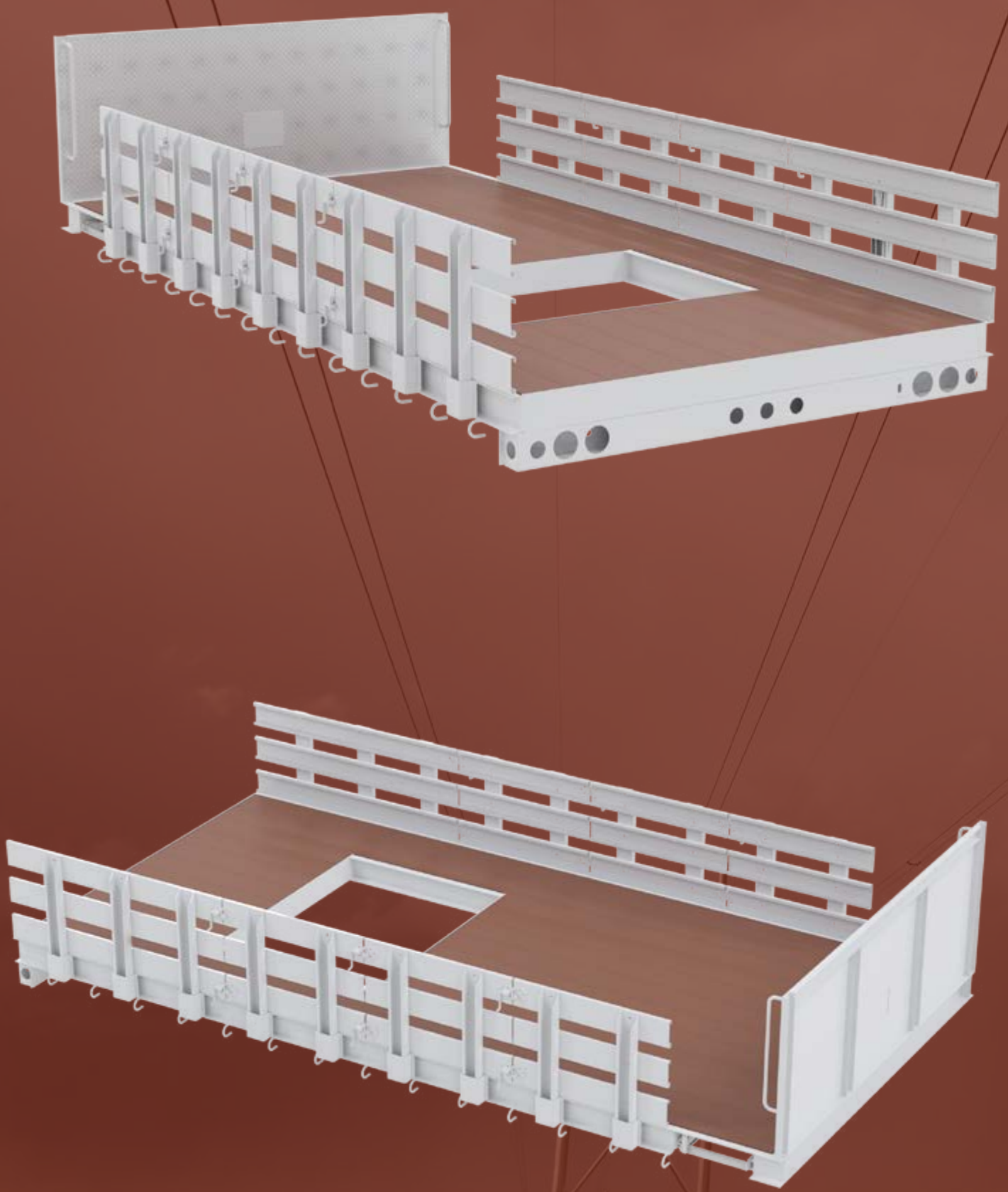

Pull out, drop down ladder to access bed area



Easy latch system to lock side panels together

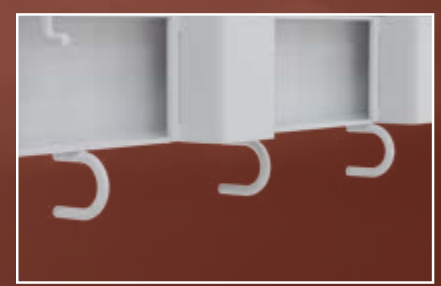

Rope hooks installed full length

CUSTOM GALVANNEAL FLATBED

LENGTH: 192" / WIDTH: 96" / HEIGHT: 36" / WEIGHT: 2,330 LBS

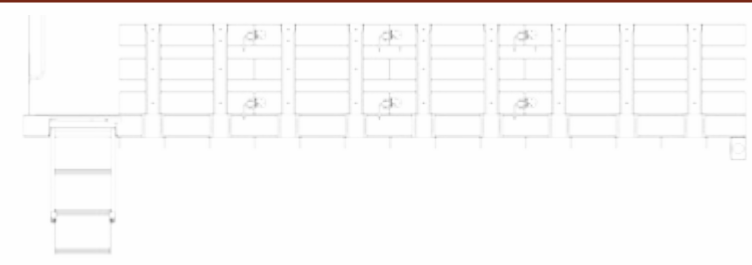

Flatbeds are a common request and are a staple in the various trades we serve. This flatbed has a wood deck over a steel frame with lightweight aluminum side rails for easy one-man operation. Rope hooks located along the bottom of the flatbed create easily accessible tie-down locations no matter where your load is sitting. Custom grab handles and stow-a-way ladder located in the front of the body keep the body looking clean and streamlined.

ADDITIONAL FEATURES:

- Custom rope hooks
- Removable side rails
- Custom side rail latches
- Stow-a-way ladders
- Custom grab handles
- Wood lined floor
- Tread plate bulkhead



Small vertical compartments near the wheel



Custom grab handle, step area and tail shelf storage.



Exterior mounted light boxes to maximize space in rear compartments

CUSTOM GALVANNEAL ENCLOSED BODY

LENGTH: 216" / WIDTH: 96" / HEIGHT: 108" / WEIGHT: 10,000 LBS

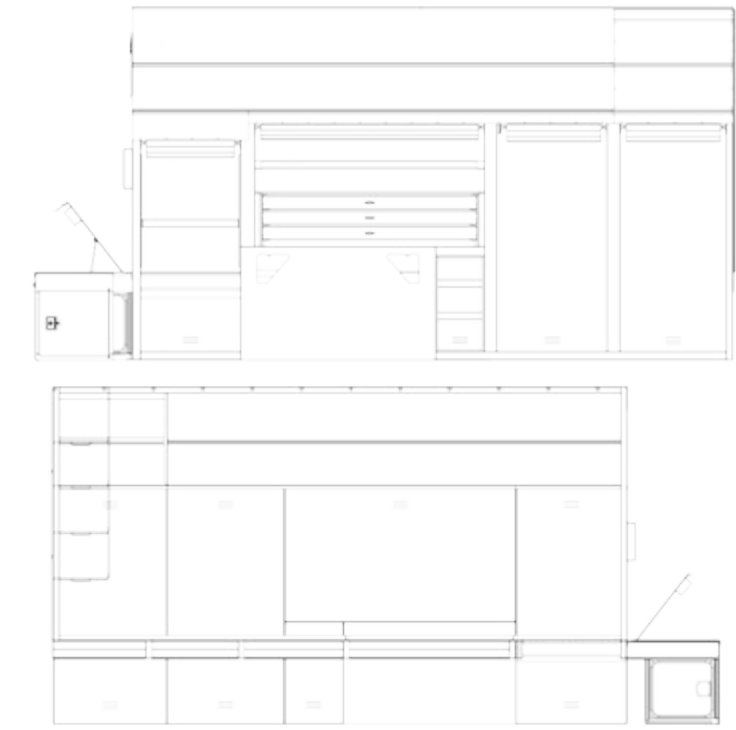

This body at 216" in length takes full advantage of maximum storage opportunities. The aluminum roll up doors on all major compartments keep the body slim and allow access in tight quarters. The interior of the body is complete with adjustable shelves and a work bench area to allow workers to work in a controlled environment. The superstructure also features a cut out on the curbside to allow for a small crane to be mounted and utilized.

ADDITIONAL FEATURES:

- Roll up aluminum doors
- Custom tail shelf storage
- Recessed rear lights
- Custom recessed step area
- Hot stick shelf
- Crane reinforcement
- Interior LED lighting



Custom strap step,
 strobe bracket,
 vise mount bracket



Custom wire reel
 platform



Punched metal box

CUSTOM GALVANNEAL LINE BODY

LENGTH: 213" / WIDTH: 94" / HEIGHT: 46" / WEIGHT 4,000 LBS

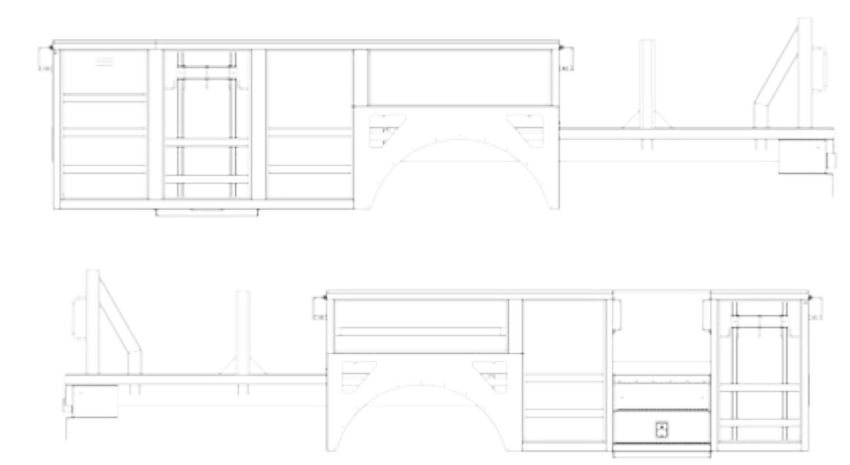

Other than obviously being a different color than the standard DB white this line body is outfitted with a unique reel carrier platform that is custom built to the customer's spec. The split tail shelf allows a possum belly compartment and a rear step access into the body. The bed area is coated with a slip resistant finish and has immediate access to the top boxes. A punched metal basket is located on top of the compartments for additional storage.

ADDITIONAL FEATURES:

- Reinforced steel frame
- Custom strobe brackets
- Rear vise mounting bracket
- Custom reel holders
- Custom compartmentalization
- Removable tail board
- Master-lock system
- Hinged step area compartment

Comp. : Dakota Bodies LLC
Street : 201 20th Ave. SE
City : Watertown, South Dakota
Zip : 57201

Phone : 605.882.1400
Fax : 605.882.0828
Mail : info@dakotabodies.com
Web : www.dakotabodies.com

// CUSTOM IS THE STANDARD //

